

TABLE OF CONTENTS

FOR DRAWING 1695

Dimensions DCU 305 R2

DIMENSIONS DCU 305 A R2 MAIN UNIT.....	1
DIMENSIONS DCU 305 P R2 MAIN UNIT.....	2
DIMENSIONS RK-66 R2 TERMINAL CARD.....	3
DIMENSIONS AK-6 ANALOG EXPANSION.....	4
DIMENSIONS MK-6 OUTPUT RELAYS.....	5
DIMENSIONS MK-14 OUTPUT RELAYS.....	6
CUTOUT DIMENSIONS.....	7



SOPHIE RADICHS VEI 7
 N-2003 LILLESTRØM
 NORWAY
 www.auto-maskin.no
 Tel:+47 64845200

PROJECT NAME: Dimensions DCU 305 R2	
PROJECT TYPE:	
CUSTOMER:	
DATE: 19.02.2008	ORDER NO:

DRAWING NO: 1695	REV:
PAGE: 0	OF 7

1 2 3 4 5 6 7 8 9 10 11 12 13 14 15 16 17 18 19 20 21 22 23 24 25 26 27 28 29 30 31 32 33 34 35 36 37 38

DIMENSIONS DCU 305 A R2 MAIN UNIT

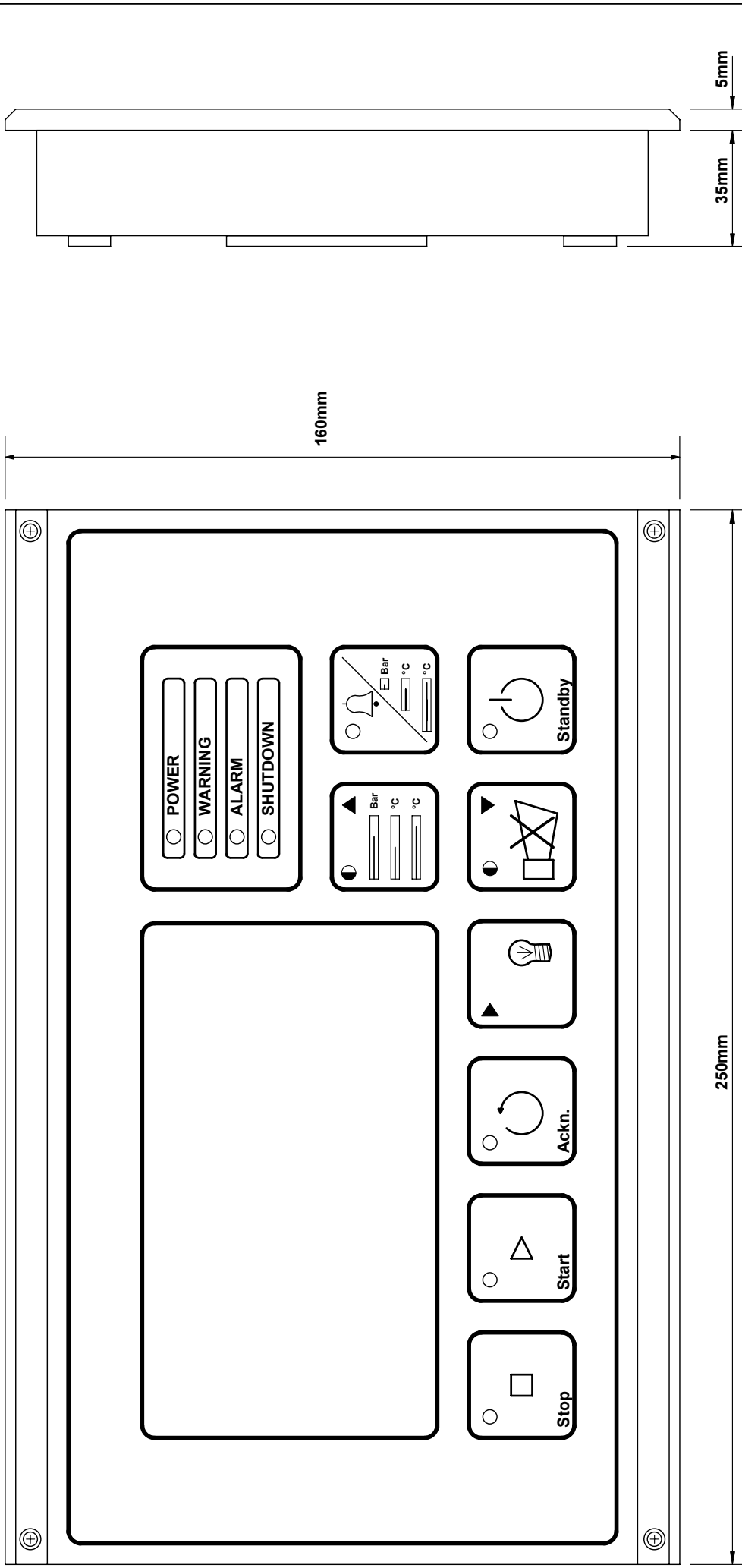

PROJECT NAME: Dimensions DCU 305 R2	
ORDER NO:	DATE: 17.09.2003
DRAWN BY: LK	DRAWING NO: 1695
CHECKED BY:	PAGE 1 OF 7
LAST CHANGED: 19.02.2008	

PAGE TITLE: DIMENSIONS DCU 305 A R2 MAIN UNIT
 PROJECT TYPE:
 CUSTOMER:
 ARCHIVE:P:\PCSELCADIPROSJEKTAUTO-MASKIN\DCU 305 R2 DIMENSIONS

SOPHIE RADICHS VEI 7
 N-2003 LILLESTRØM
 NORWAY
 www.auto-maskin.no
 Tel: +47 64845200



1 2 3 4 5 6 7 8 9 10 11 12 13 14 15 16 17 18 19 20 21 22 23 24 25 26 27 28 29 30 31 32 33 34 35 36 37 38

DIMENSIONS DCU 305 P R2 MAIN UNIT

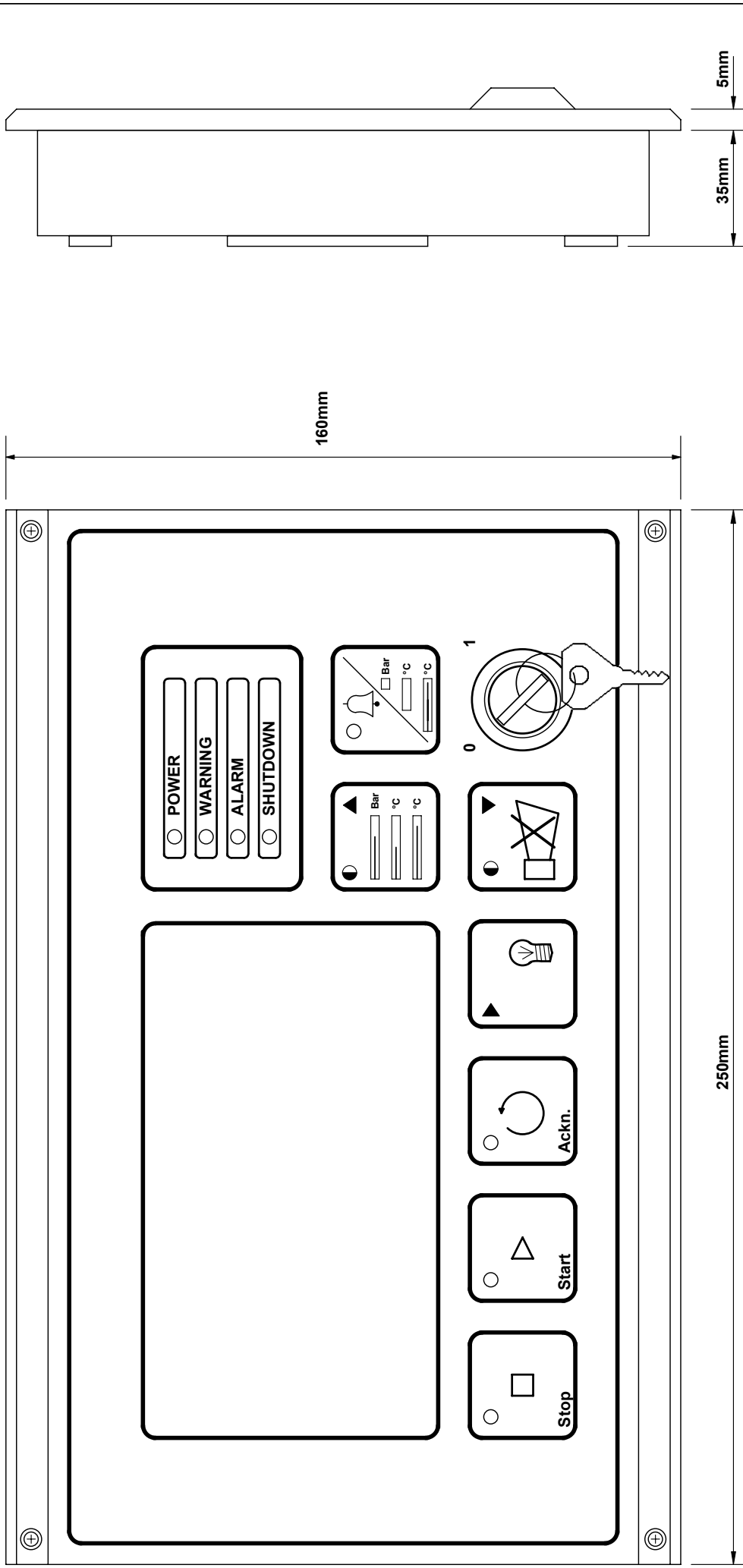

PROJECT NAME: Dimensions DCU 305 R2		ORDER NO:	DATE: 17.09.2003	DRAWING NO:	REV:
PAGE TITLE: DIMENSIONS DCU 305 P R2 MAIN UNIT		DRAWN BY: LK		1695	
PROJECT TYPE:		CHECKED BY:		PAGE 2	OF 7
CUSTOMER:		ARCHIVE:P:\PCSELCADIPROSJEKTAUTO-MASKIN\DCU 305 R2 DIMENSIONS			
SOPHIE RADICHS VEI 7 N-2003 LILLESTRØM NORWAY www.auto-maskin.no Tel:+47 64845200					



DIMENSIONS RK-66 R2 TERMINAL CARD

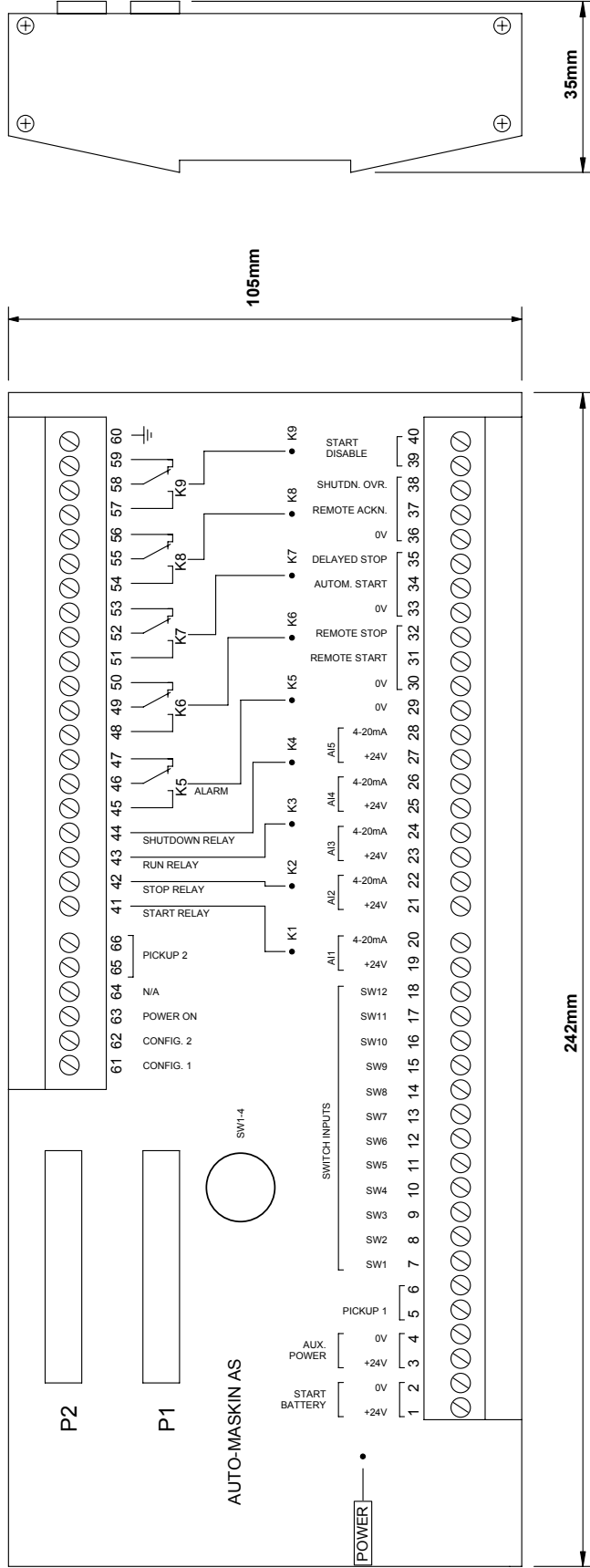

PROJECT NAME: Dimensions DCU 305 R2

ORDER NO:	DATE: 17.09.2003	DRAWING NO:	REV:
DRAWN BY: LK		1695	
CHECKED BY:		PAGE 3 OF 7	
LAST CHANGED: 19.02.2008			

PAGE TITLE: DIMENSIONS RK-66 R2 TERMINAL CARD

PROJECT TYPE:

CUSTOMER:

ARCHIVE-P:\PCSELCAD\PROSJEKT\AUTO-MASKIN\DCU 305\1695_DCU_305 R2 DIMENSIONS

SOPHIE RADICHS VEI 7
 IN-2003 LILLESTRØM
 NORWAY
 www.auto-maskin.no
 Tel: +47 64845200



1 2 3 4 5 6 7 8 9 10 11 12 13 14 15 16 17 18 19 20 21 22 23 24 25 26 27 28 29 30 31 32 33 34 35 36 37 38

DIMENSIONS AK-6 ANALOG EXPANSION

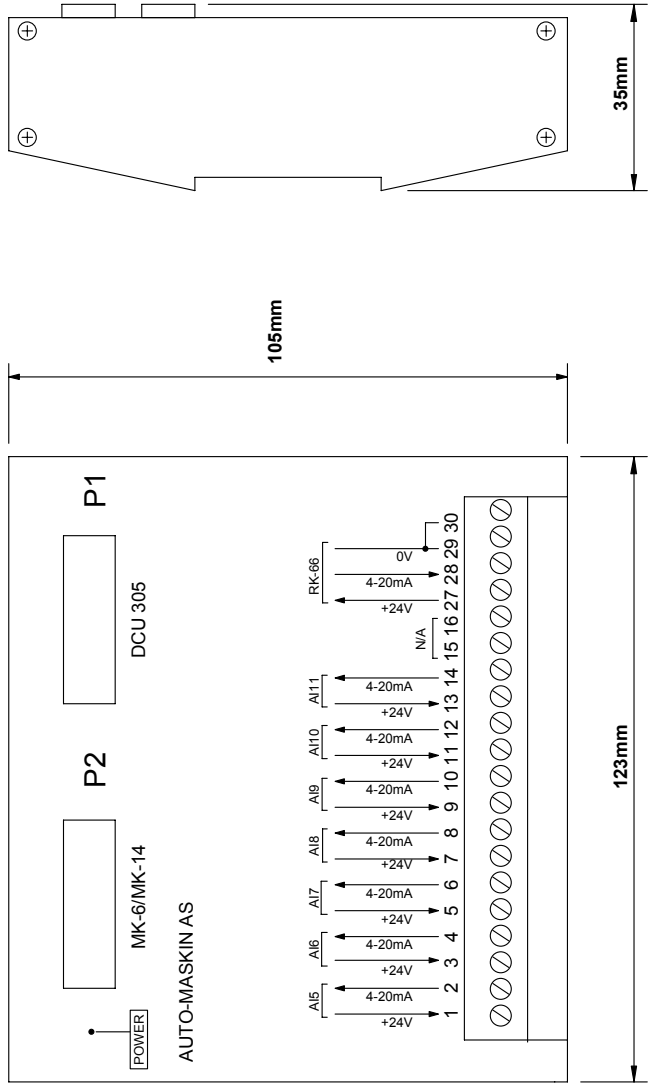

SOPHIE RADICHS VEI 7
 N-2003 LILLES TRØM
 NORWAY
 www.auto-maskin.no
 Tel:+47 64845200

PAGE TITLE: DIMENSIONS AK-6 ANALOG EXPANSION
 PROJECT TYPE:
 CUSTOMER:
 ARCHIVE: P:\PCSELCAD\PROSJEKTVAUTO-MASKIN\DCU 305\1695_DIMENSIONS

PROJECT NAME: Dimensions DCU 305 R2	
ORDER NO:	DATE: 17.09.2003
DRAWN BY: LK	DRAWING NO: 1695
CHECKED BY:	PAGE 4 OF 7
LAST CHANGED: 19.02.2008	REV:

1 2 3 4 5 6 7 8 9 10 11 12 13 14 15 16 17 18 19 20 21 22 23 24 25 26 27 28 29 30 31 32 33 34 35 36 37 38

DIMENSIONS MK-6 OUTPUT RELAYS

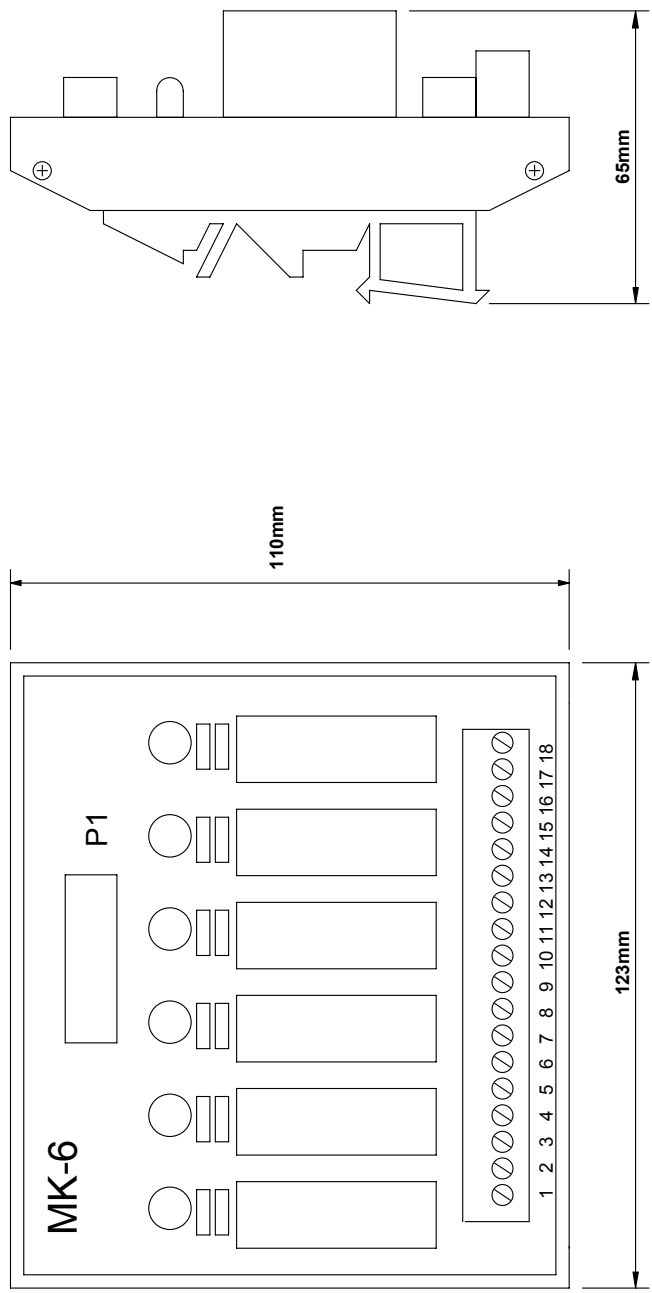

SOPHIE RADICHS VEI 7
N-2003 LILLES TRØM
NORWAY
www.auto-maskin.no
Tel:+47 64645200

PAGE TITLE: DIMENSIONS MK-6 OUTPUT RELAYS
PROJECT TYPE:
CUSTOMER:
ARCHIVE: P:\PCSELCAD\PROSJEKTVAUTO-MASKIN\DCU 305\1695_DCU 305 R2 DIMENSIONS

PROJECT NAME: Dimensions DCU 305 R2	
ORDER NO:	DATE: 17.09.2003
DRAWN BY: LK	DRAWING NO: 1695
CHECKED BY:	PAGE 5 OF 7
LAST CHANGED: 19.02.2008	REV:

1 2 3 4 5 6 7 8 9 10 11 12 13 14 15 16 17 18 19 20 21 22 23 24 25 26 27 28 29 30 31 32 33 34 35 36 37 38

DIMENSIONS MK-14 OUTPUT RELAYS

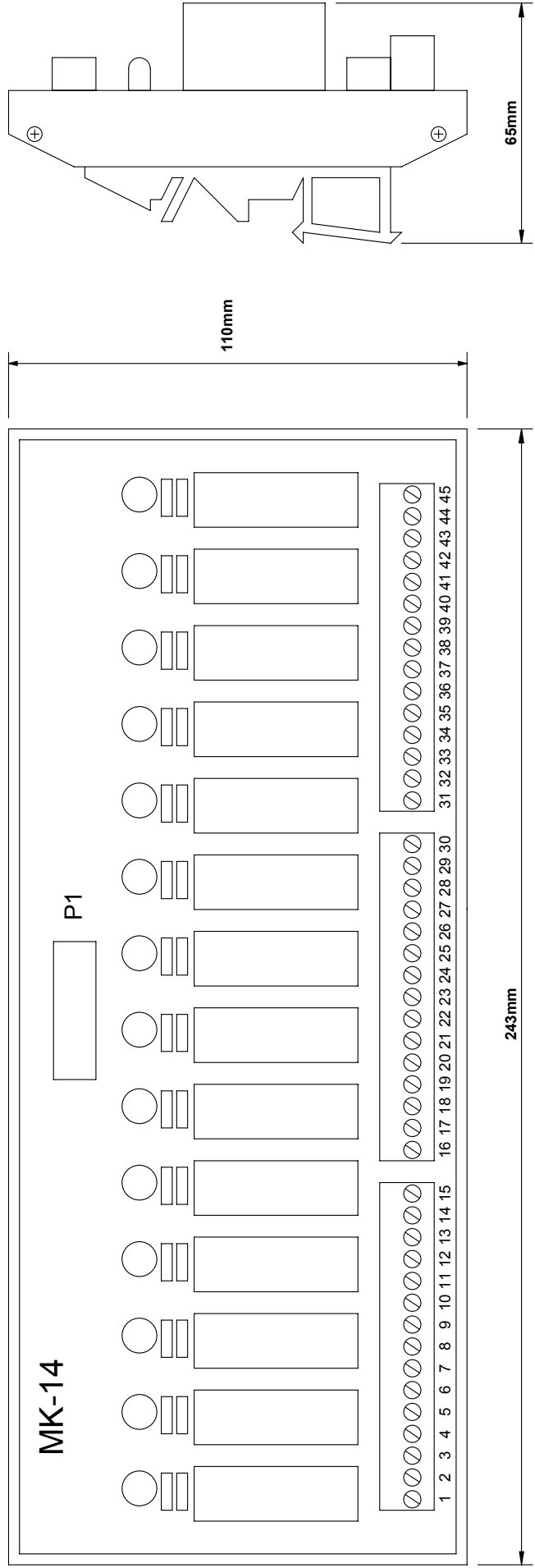

PROJECT NAME: Dimensions DCU 305 R2		ORDER NO:	DATE: 17.09.2003	DRAWING NO:	REV:
		DRAWN BY: LK		1695	
		CHECKED BY:			
		LAST CHANGED: 19.02.2008		PAGE 6	OF 7
PAGE TITLE: DIMENSIONS MK-14 OUTPUT RELAYS PROJECT TYPE: CUSTOMER:		ARCHIVE: P:\PCSELCAD\PROSJEKTVAUTO-MASKIN\DCU 305\1695_DIMENSIONS			
SOPHIE RADICHS VEI 7 N-2003 LILLES TRØM NORWAY www.auto-maskin.no Tel:+47 64645200					



1 2 3 4 5 6 7 8 9 10 11 12 13 14 15 16 17 18 19 20 21 22 23 24 25 26 27 28 29 30 31 32 33 34 35 36 37 38

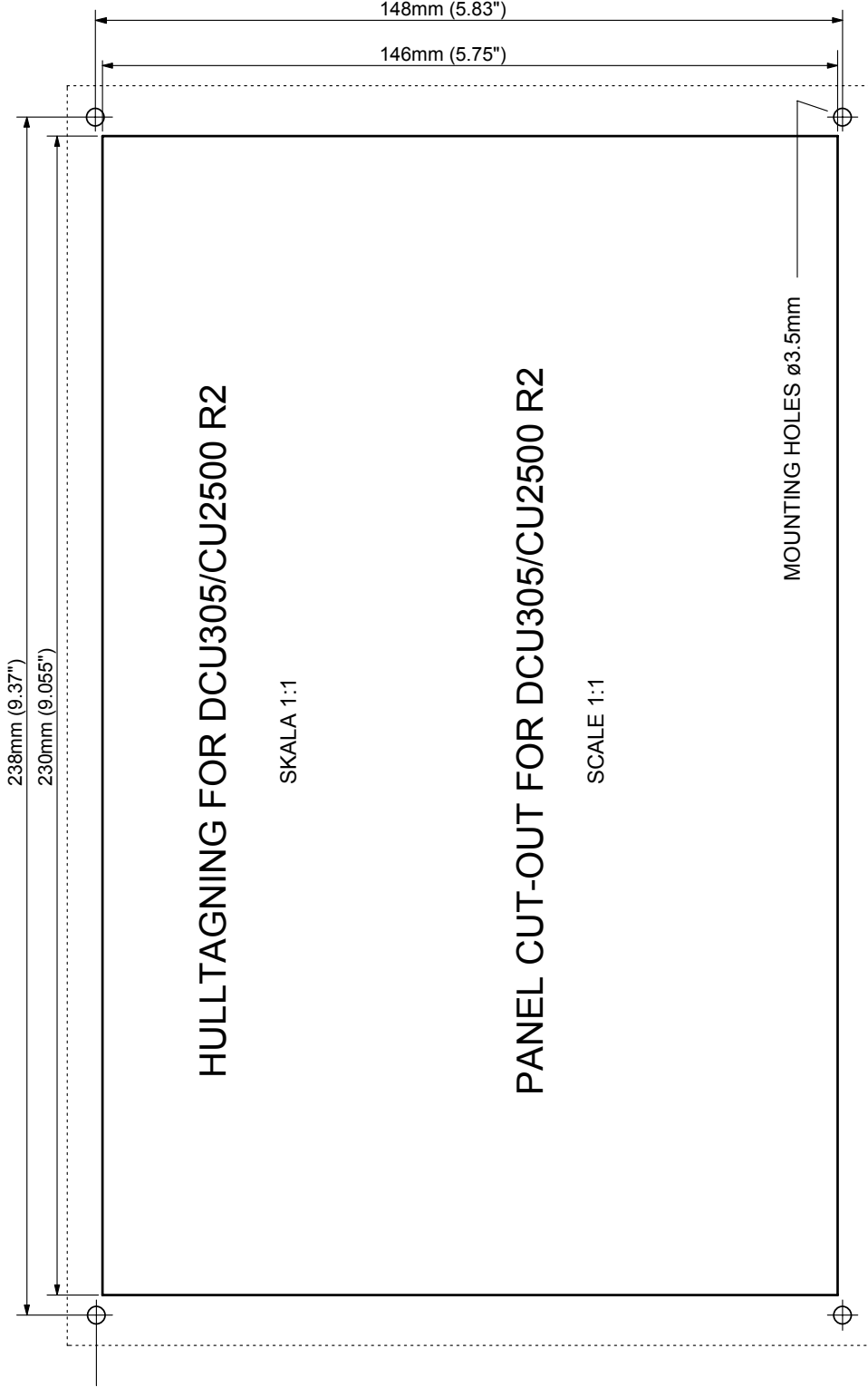

PROJECT NAME: Dimensions DCU 305 R2

ORDER NO: DATE: 17.09.2003

DRAWING NO: REV:

1695

DRAWN BY: LK

CHECKED BY:

LAST CHANGED: 19.02.2008

PAGE 7 OF 7

PAGE TITLE: CUTOUT DIMENSIONS

PROJECT TYPE:

CUSTOMER:

ARCHIVE:P:\PCSELCAD\PROSJEKTAUTO-MASKIN\DCU 305\1695_DCU 305 R2 DIMENSIONS

SOPHIE RADICHS VEI 7
N-2003 LILLESTRØM
NORWAY

www.auto-maskin.no
Tel: +47 64845200

